

DIOH-GQ-TS22C-10E/Y/S/9-24V/RG

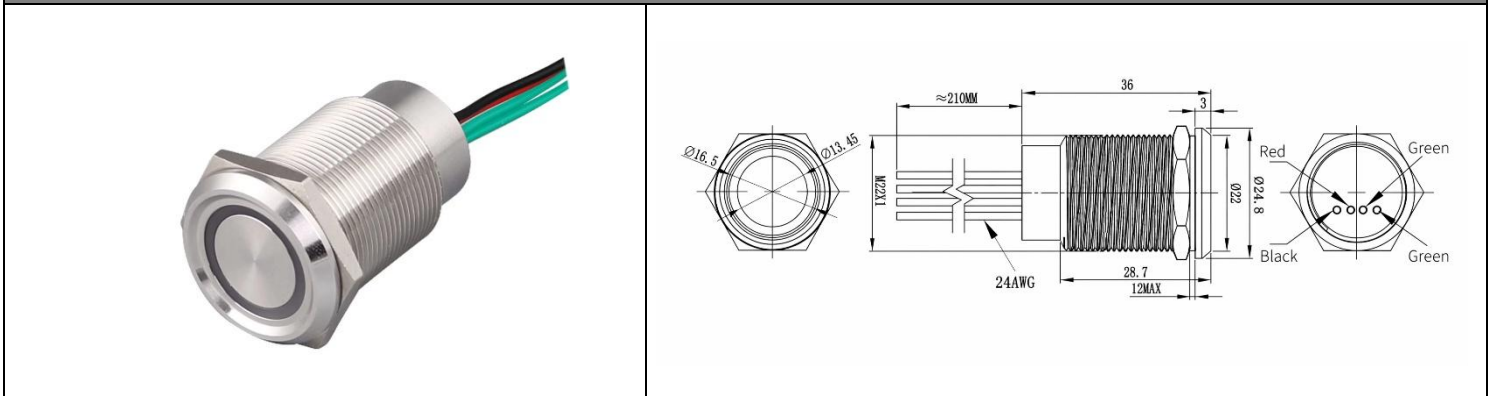

Series	GQ22	22mm Capacitive touch switch. Operation: momentary. Wire Connection
Type	Capacitive touch switch	

Mounting Diameter	Ø22 mm	Material	Stainless steel
Button Cap Shape	Concave head	Connection	Cable
Contact Current	3A / 24 VDC	IP / IK	68 / 09
Specifications	CE, ROHS, CCC, UL	Panel Thickness	1 - 12 mm

Operation Type	Momentary	Operating Temperature	-25°C to +70°C
Contact Configuration	1NO	Mechanical Lifetime	>10.000.000 Times
LED-Type	Ring LED	LED Lifetime	>50.000 Times
LED Voltage Options	6V / 12V / 24V / 110V / 220V	LED-Color	Red - Green

