

Piezo Buzzer

SGBD-85S4120



Electrical Specifications

Model	85S4120	
Operating Voltage	(VDC)	3 ~ 28
Rated Voltage	(VDC)	12
Max. Rated Current	(mA)	15
Min. Sound Output	(dBA)	87 at 30cm
Frequency	(Hz)	3900 ± 500
Tone Nature		Single
Operating Temperature	(°C)	-20 ~ +60
Weight	(g)	8

Dimensions

Top View

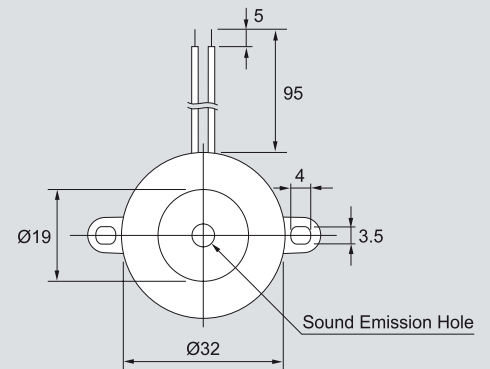

Side View

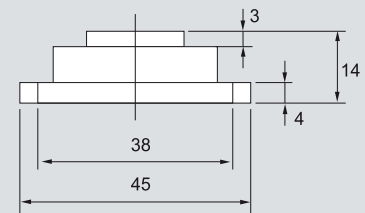

all dimensions are in mm