

Piezo Buzzer

SGBD-21S5120



Electrical Specifications

Model	21S5120	
Operating Voltage	(VDC)	3 ~ 30
Rated Voltage	(VDC)	12
Max. Rated Current	(mA)	3
Min. Sound Output	(dBA)	85 at 30cm
Frequency	(Hz)	4500 ± 500
Tone Nature		Single
Operating Temperature	(°C)	-20 ~ +60
Weight	(g)	5

Dimensions

Top View

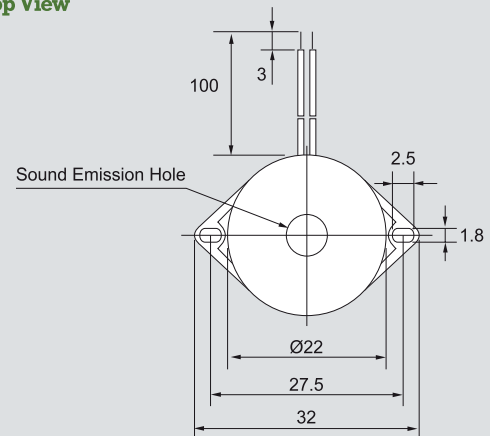

Side View

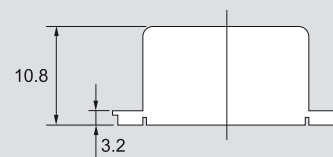

all dimensions are in mm