

Piezo Buzzer

SGBD-195S3120



Electrical Specifications

Model	195S3120	
Operating Voltage	(VDC)	3 ~ 20
Rated Voltage	(VDC)	12
Max. Rated Current	(mA)	15
Min. Sound Output	(dBA)	85 at 30cm
Frequency	(Hz)	3400 ± 500
Tone Nature		Single
Operating Temperature	(°C)	-20 ~ +65
Weight	(g)	6

Dimensions

Top View

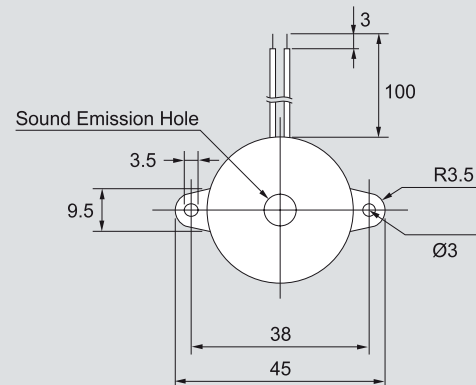

Side View

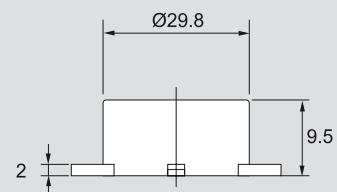

all dimensions are in mm