

External Drive Piezo Transducer

SGBD-67PZ17400



Electrical Specifications

Model	67PZ17400	
Min. Sound Output	(dBA)	80 min. (9V p-p / Square Wave / 10cm / 4000Hz)
Capacitance	(pF)	9500 ± 30% at 120Hz
Max. Input Voltage	(V p-p)	25
Operating Temperature	(°C)	-20 ~ +60
Weight	(g)	1

Dimensions

Top View

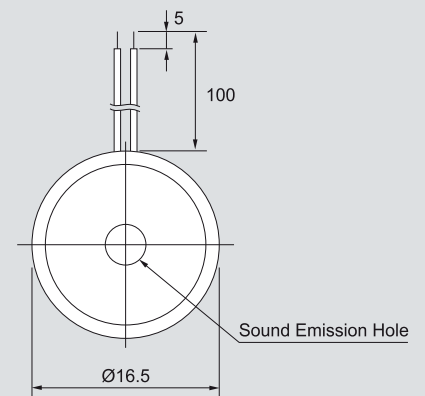

Side View

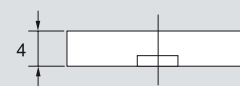

all dimensions are in mm

Frequency Response

