

External Drive Piezo Transducer

SGBD-55PZ30400



Electrical Specifications

Model	55PZ30400	
Min. Sound Output	(dBA)	85 min. (3V rms / Sine Wave / 10cm / 4000Hz)
Capacitance	(pF)	25000 ± 30% at 1000Hz
Max. Input Voltage	(V p-p)	30
Operating Temperature	(°C)	-20 ~ +70
Weight	(g)	5

Dimensions

Top View

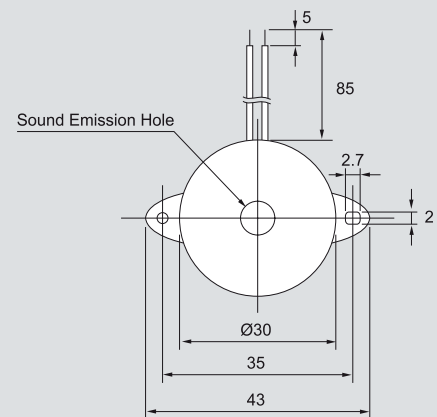

Side View

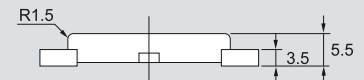

all dimensions are in mm

Frequency Response

