

Piezo Buzzer

SGBD-94S4120



Electrical Specifications

Model		94S4120
Operating Voltage	(VDC)	3 ~ 28
Rated Voltage	(VDC)	12
Max. Rated Current	(mA)	10
Min. Sound Output	(dBA)	85 at 30cm
Frequency	(Hz)	3500 ± 500
Tone Nature		Single
Operating Temperature	(°C)	-25 ~ +65
Weight	(g)	3.5

Dimensions

Top View

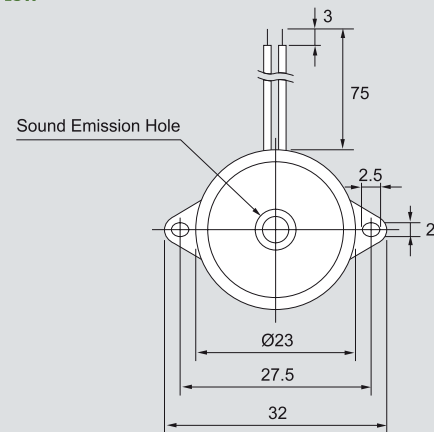

Side View

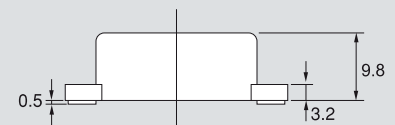

all dimensions are in mm