

External Drive Piezo Transducer

SGBD-154PZ14480



Electrical Specifications

Model	154PZ14480	
Min. Sound Output (dBA)	80 min. (5V p-p / Square Wave / 10cm / 4800Hz)	
Capacitance (pF)	12000 ± 30% at 120Hz	
Max. Input Voltage (V p-p)	30	
Operating Temperature (°C)	-20 ~ +60	
Weight (g)	3	

Frequency Response

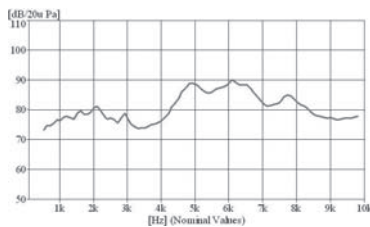

Dimensions

Top View

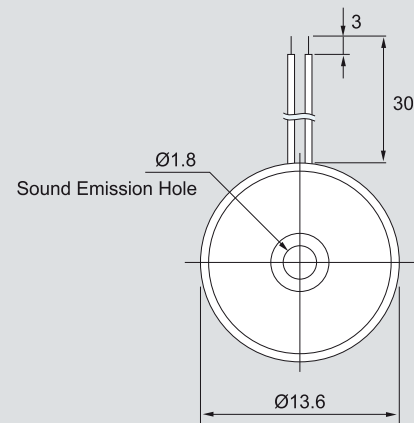

Side View

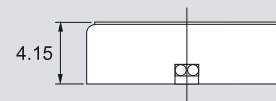

all dimensions are in mm